

harmoni lugo

Digital electric radiator



INSTRUCTION & INSTALLATION GUIDE

Introduction

harmoni digital electric radiators are programmable with an exclusive electronic temperature programmer and manufactured with quality components designed for you. **harmoni** digital electric radiators have passed the most demanding quality controls to meet with the most rigorous safety and efficiency requirements. The digital electric radiators are designed for fixed installation only and below are the main features:

- Backlight display
- Easy to follow settings and programming
- Highly accurate electronic thermostat

Please read this Instruction & Installation Guide carefully to ensure correct operation. It is important that this guide is left with the product after installation.

Contents

1. harmoni Technical Specifications.....	3
2. Installation & Safety precautions.....	4
2.1. Installation precautions.....	4
2.2. Safety precautions.....	4
3. harmoni system Installation.....	4
3.1. Mounting.....	4
3.2. Fixing the supports.....	5
4. harmoni system Information & Instructions.....	5
4.1. Keypad.....	5
4.2. Screen.....	6
4.3. Switch on & off (stand-by).....	6
4.4. Adjust the day & time.....	7
4.5. Lock the keypad.....	7
4.6. Select either MANUAL or AUTOMATIC mode.....	7
4.7. harmoni system Advanced Functions.....	10
5. Maintenance & Cleaning.....	11
6. Guarantee.....	11

2. Installation & Safety precautions (EN 60335 Standards)

Before switching on the product, please read the "Installation & Safety Precautions" in detail first to ensure the correct operation of the product.

2.1. Installation precautions

The product is designed for household or residential use. You are advised to have the product installed by an authorized professional installer. Make sure the product is properly connected to 230V and is earthed.

2.2. Safety precautions

This appliance can be used by children aged from 8 years and above and persons with reduced physical sensory or mental capabilities or lack of experience and knowledge if they are supervised or have been given instruction concerning use of the appliance in a safe way and understand the hazards involved. Children should not play with the appliance. Cleaning and user maintenance should not be carried out by children without supervision. Children must be supervised at all times to ensure that they do not interfere with the product.

This product is filled with a precise amount of special oil that does not need any maintenance. Any repairs requiring the opening of the oil tank must only be done by an official **harmoni** installer or its after-sales service personnel, who should also be notified should an oil leak be noticed. The regulations on discarding oil when the heater is being disposed of must be observed. If the power cable is damaged, it must be replaced by the manufacturer, its after-sales service or authorized personnel in order to avoid any damage.

3. harmoni system Installation

3.1. Mounting

The product works by means of natural air convection (Figure 1). In order to achieve optimal functioning and an even distribution of heat, the lower part of the product, once mounted on the wall, must be at least 10-12cm from the floor, and 30cm at the most. As for the sides and above, a minimum distance of between 10-12cm must be left from any wall or brickwork in order for it to function correctly (Figure 2).

Figure 1

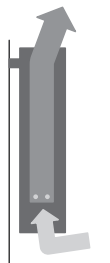
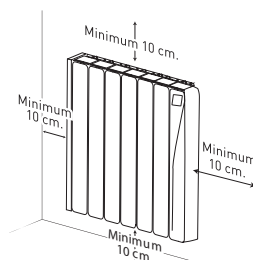
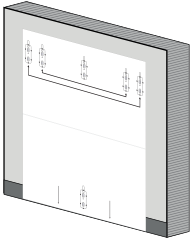
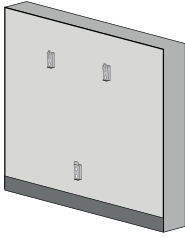
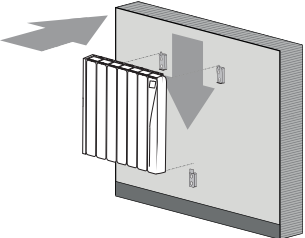

Figure 2



3.2. Fixing the supports





Inside the packaging you will find a fixing kit. Please find the instructions below:

		
<ol style="list-style-type: none"> 1. Choose the right part of the wall. 2. Place the mounting stencil on the wall, marking the places for the holes. 	<ol style="list-style-type: none"> 3. Remove the stencil and make the holes in the wall. 4. Fix the supports using the plugs and screws provided, or others suitable for the wall type. 	<ol style="list-style-type: none"> 5. Check the correct positioning of the lower support. 6. Align the product with the top supports. 7. Place the product in the supports.

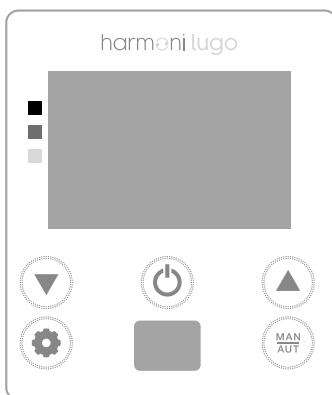
4. harmoni system Information & Instructions

4.1. Keypad



				
<p>Settings / Back</p>	<p>Decrease Temperature / Move down</p>	<p>On/Off (stand-by) / Confirm</p>	<p>Increase Temperature / Move up</p>	<p>MANUAL / AUTO function</p>

4.2. Screen

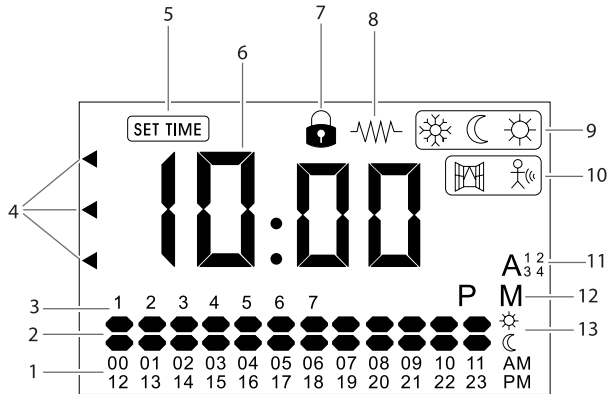

1	Programming - Hours of the Day available
2	Programming - Hours of the Day selected
3	Days of the Week
4	Energy Consumption indicator
5	SET TIME setting indicator
6	Current time/temperature
7	Keypad Locked indicator
8	Heating element on indicator
9	COMFORT / ECO / ANTI-FROST mode indicator
10	OPEN WINDOWS / PRESENCE DETECT function indicator (*Only available upon demand*)
11	Pre-installed programmes indicator
12	MANUAL / PILOT function indicator (*Only available upon demand*)
13	Programming - COMFORT / ECO function indicator





	Keypad locked
	Heating element on
	ANTI-FROST mode on
	ECO mode on
	COMFORT mode on
	OPEN WINDOWS function on
	PRESENCE DETECT function on (*Only available upon demand*)
	Pre-installed programme active
	MANUAL function active
	PILOT function active (*Only available upon demand*)









4.3. Switch on & off (stand-by)

To switch the product on, please press the button once. To switch the product off, please press the button again.

When you switch the product on for the first time you will be prompted to set the day and time. Use the buttons to select the correct hour and press the button to confirm. Next use the buttons to select the correct minute and press the button to confirm. Then use the buttons to select the correct day and press the button to confirm.

4.4. Adjust the day & time



To adjust the day or time of the product, please press the  button to access the Settings Menu. Then you will need to use the   buttons to scroll to the **SET TIME** menu on the screen and press the  button to confirm.

Use the   buttons to select the correct hour and press the  button to confirm. Next use the   buttons to select the correct minute and press the  button to confirm. Then use the   buttons to select the correct day and press the  button to confirm.



4.5. Lock the keypad

To lock the keypad, please press and hold the   buttons at the same time for 3 seconds. A  icon will appear at the top of the screen.

To unlock the keypad, press and hold the   buttons again at the same time for 3 seconds. The  icon will disappear from the top of the screen.



4.6. Select either the MANUAL, AUTOMATIC or PILOT mode (*Only upon demand.*)

To select either the MANUAL, PILOT and AUTO, AUTO 1, AUTO 2, AUTO 3 and AUTO 4 modes you need to press the  button and keep pressing until the mode you want is highlighted.

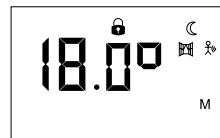
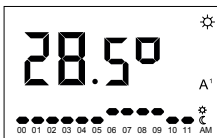

On the display panel, the $A_{3/4}^{1/2}$ icon will appear when you are in one of the AUTO modes (1-4), the M icon will appear when you are in MANUAL mode and the P icon will appear when in PILOT mode.





4.6.1. MANUAL mode

When MANUAL mode is selected the set temperature, MANUAL mode icon, COMFORT/ECO/ANTI-FROST icon and the time/day of the week will be displayed on the screen. The set temperature and the hour will alternate every 5 seconds on the screen.

In MANUAL mode you can choose a set temperature and the corresponding COMFORT/ECO/ANTI-FROST icon will appear on the screen according to the ranges below:

 COMFORT	21 - 30 °C
 ECO	7.5 - 20.5 °C
 ANTI-FROST	7 °C

To adjust the set temperature:

Use the   buttons to either increase or decrease the temperature respectively. When you choose a temperature in the table above, the corresponding icon will appear on the screen.

When the room temperature is lower than the set temperature on the display panel, the product will display the -symbol in the top right of the screen.















4.6.2 AUTOMATIC mode

When the AUTOMATIC mode is selected, this activates the programming already established in the product. You can choose from one of the 4 pre-installed programmes within the harmoni product:

A¹	A²	A₃	A₄
Auto 1	Auto 2	Auto 3	Auto 4

You can also modify these pre-installed programmes to suit your needs. Please see page 9 for a step by step guide on how to activate or modify one of the pre-installed programmes.

AUTO Pre-Installed Programme Scheduling:





		Time																									
			00	01	02	03	04	05	06	07	08	09	10	11	12	13	14	15	16	17	18	19	20	21	22	23	
A1	Mon - Fri	 COMFORT																									
		 ECO																									
	Sat - Sun	 COMFORT																									
		 ECO																									
A2	Mon - Fri	 COMFORT																									
		 ECO																									
	Sat - Sun	 COMFORT																									
		 ECO																									
A3	Mon - Sun	 COMFORT																									
		 ECO																									
A4	Mon - Fri	 COMFORT																									
		 ECO																									
	Sat - Sun	 COMFORT																									
		 ECO																									

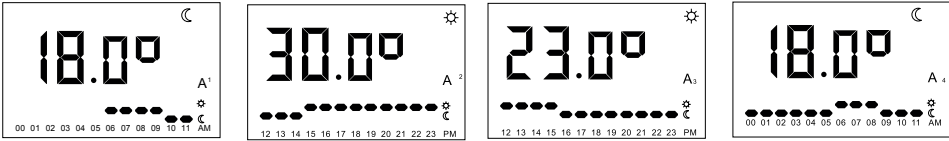











To activate one of the pre-installed programmes:

Press the  button on the keypad until either AUTO, AUTO 1, AUTO 2, AUTO 3 or AUTO 4 is highlighted. The pre-installed programme will now be active and the corresponding icon will appear on the screen.







To modify one of the pre-installed programmes:

STEP 1 - You will need to establish the set temperature of the COMFORT/ECO/ANTI-FROST modes first. Please press the  button to access the Settings Menu. Then you will need to use the   buttons to scroll between the menus to select the  menu on the screen and press the  button to confirm. The COMFORT temperature is adjusted first.

Press the   buttons to either increase or decrease the temperature respectively within the pre-set COMFORT  temperature range (see table above). Press the  button to confirm and you will then move to the ECO  temperature settings. Use the   buttons to either increase or decrease the temperature respectively within the pre-set ECO temperature range. Press the  button to confirm and you will then move to the ANTI-FROST  temperature settings. Use the   buttons to either increase or decrease the temperature respectively and press the  button to confirm.





STEP 2 - Press the  button on the keypad until the programme that you wish to modify (AUTO, AUTO 1, AUTO 2, AUTO 3 or AUTO 4) is highlighted. The pre-installed programme will now be active and the corresponding icon will appear on the screen.

STEP 3 - Press AND hold the  button on the keypad for 2 seconds to modify the hours and days. The days can be modified first. Use the   buttons to select the chosen days and press the  button to select the days you want to modify.



STEP 4 - Then you will move onto setting the mode for each hour, of the day which will begin at 0h (midnight). You will need to go through each hour and select a mode for each hour.



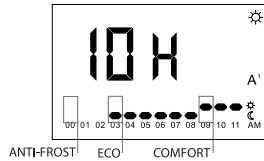







Select the mode by pressing the  button - press once for COMFORT, press twice for ECO and press three times for ANTI-FROST. To move onto the next hour, use the   buttons.



Once all 24 hours of the day have been assigned a mode, press the  button to save your settings and return to the main screen.

4.7. harmoni system Advanced Functions

The harmoni system includes three advanced functions - see below.

To activate or deactivate one of the below functions, please press the  button to access the Settings Menu. Then you will need to use the   buttons to scroll between the menus to select the OPEN WINDOWS/PRESENCE DETECT function. Once selected, press the  button and use the   buttons to activate or deactivate the OPEN WINDOWS function. If you wish to activate the PRESENCE DETECT function, please press the  button again and use the   buttons to activate or deactivate the PRESENCE DETECT function. Press the  button to save your settings and return to the main screen.

4.7.1. OPEN WINDOWS function

The harmoni system has the OPEN WINDOWS  function set to ON to begin with. This function is activated when the temperature sensor detects a drop of 4°C from the set temperature within a 30 minute time period. The OPEN WINDOWS function will be active for 2 hours. When the OPEN WINDOWS function is activated, the product will move into ANTI-FROST mode at 7°C.

4.7.2. PRESENCE DETECT function (*Only upon demand.*)



The harmoni system has a PRESENCE DETECT  function installed within the product. This function detects movement (or presence) around the product.

If no presence is detected within 60 minutes then the product will automatically decrease the set temperature by 1°C. If no movement is detected for 120 minutes then the product will automatically decrease the temperature by a further 1°C. If there is no movement within 180 minutes then the product will automatically decrease the temperature by a further 1.5°C.

If a presence is detected by the product at any moment, then the product will automatically increase the temperature back to the previously established user set temperature.

4.7.3. Energy Consumption Indicator

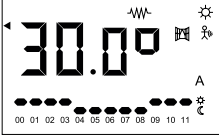
The harmoni system has a unique energy consumption indicator so you can monitor your energy expenditure. The  icon will appear down the left side of the screen when switched on to indicate the expenditure level.

		
24.5 - 30°C	19 - 24°C	< 19°C
Within this temperature range, you are using a high amount of energy.	Within this temperature range, you are using an average/medium amount of energy.	Within this temperature range, you are using a low amount of energy.

5. Maintenance & Cleaning

The product does not require any type of maintenance. We recommend that all parts of the product are kept clean (behind, underneath, upper fins, etc.). Do not use any abrasive product on the aluminium. Clean it with a damp cloth and a pH neutral soap, and the control panel with a dry cloth.

European Directive 2012/19/UE



Under the European Directive 2012/19/UE on waste electrical and electronic equipment (WEEE), the product cannot be disposed in the usual council bins and containers. They must be separated to optimize the recovery and recycling of all of the components and materials and reducing the impact to human health and the environment. The symbol of the container crossed out over a horizontal line is marked on all of harmoni products to remind the consumer of the obligation to separate them on disposal.

The consumer should contact the local authority or original point of sale to learn more about the correct disposal of this product.

6. Guarantee

In this section, we hereby describe the guarantee conditions which the buyer acquires on buying a new harmoni product. These conditions comply with all the rights construed in the national legislation in force, as well as any additional rights and guarantees which are offered by harmoni.

6.1. Any incident that you might detect in your harmoni product can be sorted by the product seller or quickly by the manufacturer. Please **contact harmoni by telephoning 01473 559088** for technical support.

SERIAL NUMBER	 IP24						
	8437007080872014442400000 1				230 V~	50Hz	1100 W
	TYPE: RK6154311 REFERENCE: LUGOHS1100 MODEL: HARMONI LUGO 10 ELEM						

You will need to state the product reference (located on the label indicating product features), serial number, proof of purchase and the type of incident at hand when contacting us so that we can check the guarantee.

In addition, please attach a copy of the product invoice.

6.2. harmoni guarantees that there are no material defects of design or manufacture at the time of original acquisition and guarantees the aluminium for a period of 120 months and 24 months for any electronic and electrical components.

6.3. If during the guarantee period, the product does not work correctly under normal use, and any design, material or manufacturing defect is found, harmoni will repair or substitute the product as it may see fit, in accordance with the terms and conditions as follows:

6.3.1. The guarantee is only applicable if the original guarantee is issued by the seller and when the said guarantee is filled in correctly including product reference, series number (marked on the product's label indicating technical features), purchase date and the seller's stamp.

harmoni reserves the right to reject the guarantee service when this information has been removed or modified after the original product purchase.

6.3.2. The guarantee only applies to those cases that concern material, design and manufacturing defects, and under no circumstances covers damage to the product for the following reasons:

6.3.2.1 Incorrect use of the product, i.e. used for other purposes that are not construed as its normal use or for not respecting the instructions of use and maintenance given by harmoni as well as incorrect installation or use of the product that may not comply with the current technical standards of safety.

Corrosion caused by direct exposure to salt water is excluded from the guarantee. When the product is installed no more than 200m from the coast the guarantee for damages caused by corrosion the period will be reduced by 50%.

6.3.2.2 Any unauthorized repairs carried out by unauthorized technicians or opening of the product by unauthorized people.

6.3.2.3 Any accidents that are deemed outside the control of harmoni, such as lightning, fires, floods, public disorders, etc.

6.3.3. Any repairs or substitutions that are included in this guarantee do not allow any additions or new periods of guarantee.

6.3.4. Any repairs or substitutions covered under this guarantee must be parts that are functionally equivalent. The defective parts or parts removed or replaced shall become the property of harmoni.

6.4. The technical service of harmoni will advise you if you need to buy any parts not covered under the guarantee or out of guarantee.

6.5. This guarantee does not affect the buyer's legal rights stipulated in the current national legislation, nor affects those rights against the distributor or installer that could come forth in compliance with the purchase contract.

6.6. In the absence of a national legal legislation applicable, this guarantee shall prevail and may be construed as the buyer's only protection. harmoni, its offices, distributors and installers may not be held responsible for any accidental damage that emerges due to infringement of any rules implicitly related to this product.

GUARANTEE CERTIFICATE			
Please fill in the product details below:			
PRODUCT REFERENCE NO.		PRODUCT SERIAL NO.	
PRODUCT NAME		PURCHASE DATE*	
Please fill in your details below:			
FIRST NAME		SURNAME	
ADDRESS			
COUNTY			
POSTCODE		TELEPHONE NO.	
EMAIL			
In order to obtain the harmoni guarantee, an authorised installer/electrician must fill in the details below:			
INSTALLER / ELECTRICIAN NAME			
INSTALLATION DATE*		PRODUCT NAME	
STAMP*		SIGNATURE	

PLEASE NOTE:

This Guarantee Certificate must be completed in full in order to obtain guarantee rights. The purchase date, installation date and the stamp are compulsory. Please keep the completed guarantee safe.

* Compulsory fields to be completed.

NOTES:

harmoni

Edison House
Edison Close
Ransomes Europark
Ipswich
Suffolk IP3 9GU

T: 01473 559088

harmoni cannot accept any responsibility for any errors in catalogues, brochures and other printed materials. harmoni reserves the right to alter its products without notice. This also applies to products already on order provided that such alterations can be made without subsequent changes to specifications already agreed. All trademarks in this material are the property of harmoni. harmoni and the harmoni logotypes are trademarks of Edison House Ltd. All rights reserved.

IMHRUK17V2